

DESCRIPTION

- 20.30mm (0.8") Dual Digit Numeric Display Series
- Standard Brightness
- Low Current Operation
- Excellent Character Appearance
- Easy Mounting on PC Boards or Sockets



Package Dimensions & Internal Circuit Diagram

8021 Series

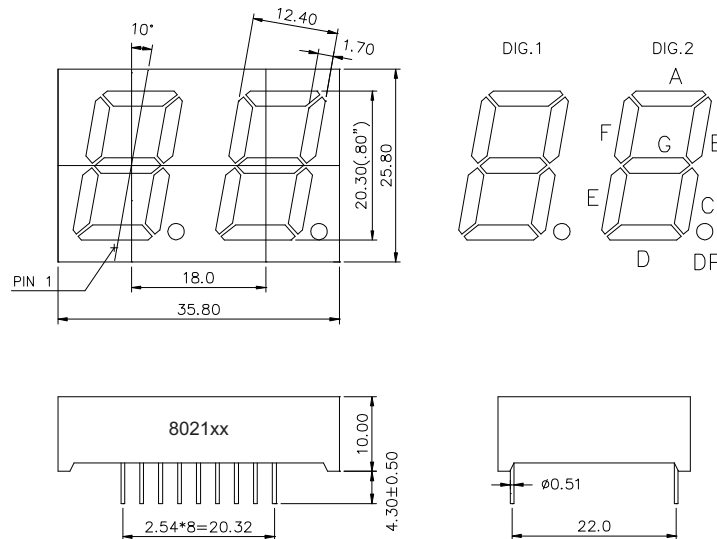

8021Ax

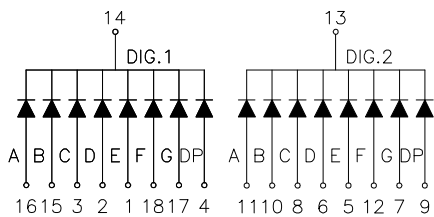

8021Bx

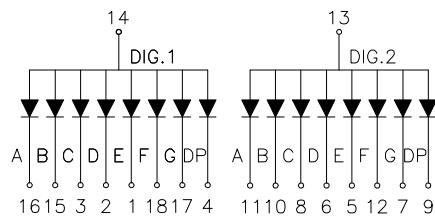

Notes:

All dimensions are in millimeters (inches)
 Tolerance is ± 0.25 (0.01") unless otherwise noted.
 Specifications are subject to change without prior notice.

Absolute Maximum Ratings (Ta = 25°C)

Parameter	Symbol	Test Condition	Value		Unit
			Min	Max	
Reverse Voltage	V_R	$I_R = 30 \mu A$	5	-----	V
Forward Current	I_f	-----	-----	20	mA
Power Dissipation	P_d	-----	-----	100	mW
Pulse Current	I_{peak}	Duty = 0.1ms, 1KHz	-----	150	mA
Operating Temperature	T_{opr}	-----	- 40	+85	°C
Storage Temperature	T_{str}	-----	- 40	+85	°C

XX :Surface / Epoxy Color :

Surface Color Number	White 0	Black 1	Gray 2	Red 3	4	5
Epoxy Color Number	White Diffused 0	Red Diffused 1	Green Diffused 2	Yellow Diffused 3	Blue Diffused 4	Water Clear 5